

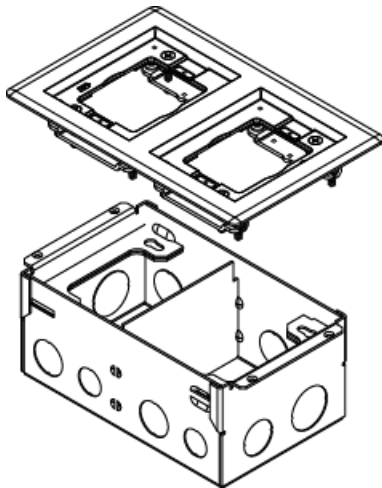

Wiremold
880W2827B Series Two-Gang Steel Floor Box for Wood Floors
Part No. 880W2827B



880W2 Floor Box with 827B Brass Flange included. Flange can be used for tile or carpet applications. Order cover separately.

Features & Benefits

880W2 Floor Box with 827B Brass Flange included. Flange can be used for tile or carpet applications. Order cover separately.

Specifications

General Info

Product Line	Wiremold	UPC Number	786564035565
Country Of Origin	Mexico	Construction	Not Assembled
Application Sector	Commercial	Standard	cULus Listed Metallic Outlet Boxes: File E2961 Guide QCIT Meets Article 314.27(C) of NEC.
Type	Floor Box		

Listing Agencies / 3rd Party Agencies

cULus ListingNumber	E2961	cULus Listed	Yes
---------------------	-------	--------------	-----

Buy American Act Compliance

NAFTA	Yes
-------	-----

Additional Information

RoHS Conformant	Yes
-----------------	-----

Technical Information

Cable Entry

Through Floor
