

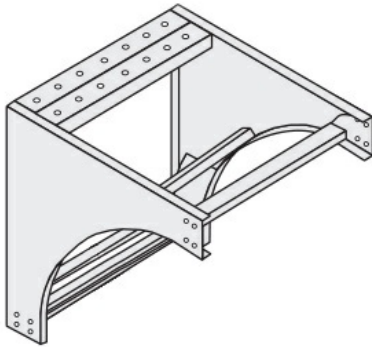

**Cablofil**  
**Vertical Support Elbow**  
Part No. P035516



Choose from an extensive selection of metallic ladder tray with a variety of rung and bottom styles to choose from. Finishes include steel, 304L and 316L stainless steel to meet the needs of any application. Rail heights range from 4" to 7" and width sizes are available up to 36".

## Features & Benefits

---

Splices included

## Specifications

---

### General Info

---

Product Line	Cablofil	Finish	GC
UPC Number	800388390539	Country Of Origin	Mexico

---

### Dimensions

---

Product Width US	6.0 in	Product Weight US	19.141 lb
Product Volume US	1.681 cu ft	Product Depth US	22.0 in
Product Height US	22.0 in		

---

### Buy American Act Compliance

---

BAA	Yes
-----	-----

---