

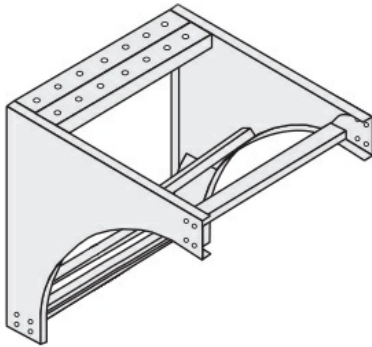

**Cablofil**  
**Vertical Support Elbow**  
Part No. P036366



Choose from an extensive selection of metallic ladder tray with a variety of rung and bottom styles to choose from. Finishes include steel, 304L and 316L stainless steel to meet the needs of any application. Rail heights range from 4" to 7" and width sizes are available up to 36".

## Features & Benefits

---

Splices included

## Specifications

---

### General Info

---

Product Line	Cablofil	Finish	GC
UPC Number	800388392243	Country Of Origin	Mexico

---

### Dimensions

---

Product Width US	18.0 in	Product Weight US	46.05 lb
Product Volume US	13.5 cu ft	Product Depth US	36.0 in
Product Height US	36.0 in		

---

### Buy American Act Compliance

---

BAA	Yes
-----	-----

---